

Operation Manual of Controller SR609C

For Pressurized Integrated Solar System



Read the instruction carefully please before operation!

Content

1. Safety information.....	3
1.1 Installation and commissioning.....	3
1.2 Liability waiver.....	3
1.3 Signal description.....	4
2. Installation.....	4
2.1 Mounting controller.....	4
2.2 Power connection.....	5
2.3 Terminal port connection.....	6
3. System diagram.....	8
4. Functions operation.....	9
4.1 Signals on display and function code.....	9
4.2 Button Description.....	10
4.3 Menu structure.....	12
4.4 Menu description.....	13
5. Main functions.....	14
5.1 Setting time.....	14
5.2 THEH Timing heating.....	14
5.3 M.H Manual heating.....	16
5.4 Intelligent heating mode.....	17
5.5 Economic mode.....	18
6. Additional functions.....	18
6.1 TCYC Setting the temperature / flow for DHW pump running within three time-sections.....	18
6.2 AHO Automatically thermostat function.....	24
6.3 OTF Three time-sections set (Timer function).....	25
6.4 PHTC Time controlled pipe belt heating protection.....	27
6.5 TDIS Thermal disinfection.....	29

6.6 CFR Tank anti-freezing protection.....	30
6.7 UNIT Celsius degree and Fahrenheit unit switch.....	31
6.8 BEEP Beeper error warning	32
6.9 RST Reset function.....	32
7. View the measuring value.....	32
8. Protection function.....	33
8.1. Memory protection	33
8.2 Screen protection	33
8.3 Trouble protection	33
9. Quality Guarantee	33
10. Technical specification	33
11. Delivery list.....	34

1. Safety information

We have carefully checked the text and pictures of this manual and provided the best of our knowledge and ideas, however inevitable errors maybe exist. Please note that we cannot guarantee that this manual is given in the integrity of image and text, incorrect, incomplete and erroneous information and the resulting damage we do not take responsibility.

1.1 Installation and commissioning

- When laying wires, please ensure that no damage occurs to any of the constructional fire safety measures presented in the building.
- The controller must not be installed in rooms where easily inflammable gas mixtures are presented or may occur.
- The permissible environmental conditions can't be exceeded at the site of installation.
- Before connecting the device, make sure that the energy supply matches the specifications that controller requires.
- All devices connected to the controller must conform to the technical specifications of the controller.
- All operations on an open controller are only to be conducted cleared from the power supply. All safety regulations for working on the power supply are valid.
- Connecting and /or all operations that require opening the collector (e.g. changing the fuse) are only conducted by specialists.

1.2 Liability waiver

The manufacturer can't monitor the compliance with these instructions or the circumstances and methods used for installation, operation, utilization and maintenance of this controller. Improper installation can cause damages to material and person. This is the reason why we do not take over responsibility and liability for losses, damages or cost that might arise due to improper

installation, operation or wrong utilization and maintenance or that occurs in some connection with the above-mentioned. Moreover, we do not take over liability for patent infringements or infringements occurring with the use of this controller on the third parties' rights. The manufacturer reserves the right to put changes to product, technical data or installation and operation instructions without prior notice. As soon as it becomes evident that safe operation is no longer possible (e.g. visible damage). Please immediately take the device out of operation. Note: ensure that the device can't be accidentally placed into operation.

1.3 Signal description



Safety indication: Safety instructions in the text are marked with a warning triangle. They indicate measures which can lead to injury of person or safety risks.

Operation steps: small triangle “▶” is used to indicate operation step.



Notes: Contains important information about operation or functions.

2. Installation

2.1 Mounting controller

- Size of controller for electrical heater of 1500W

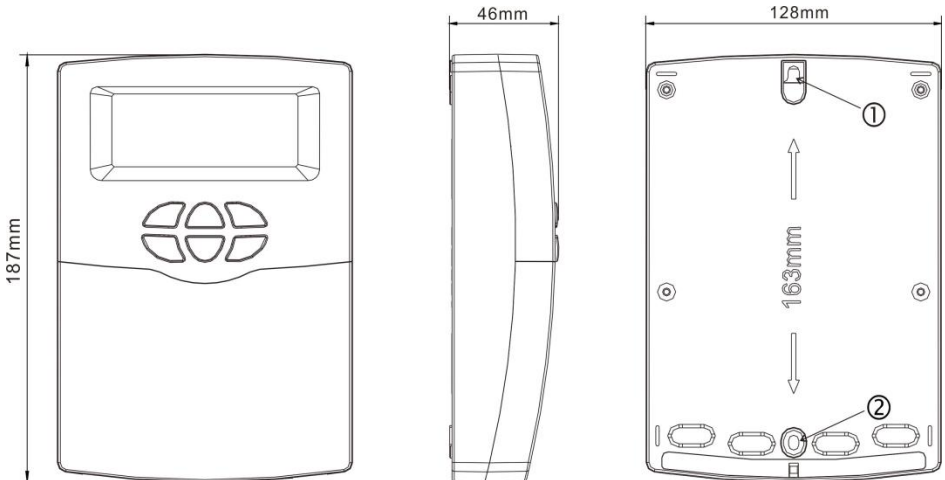

- Size of controller for electrical heater of 3000W

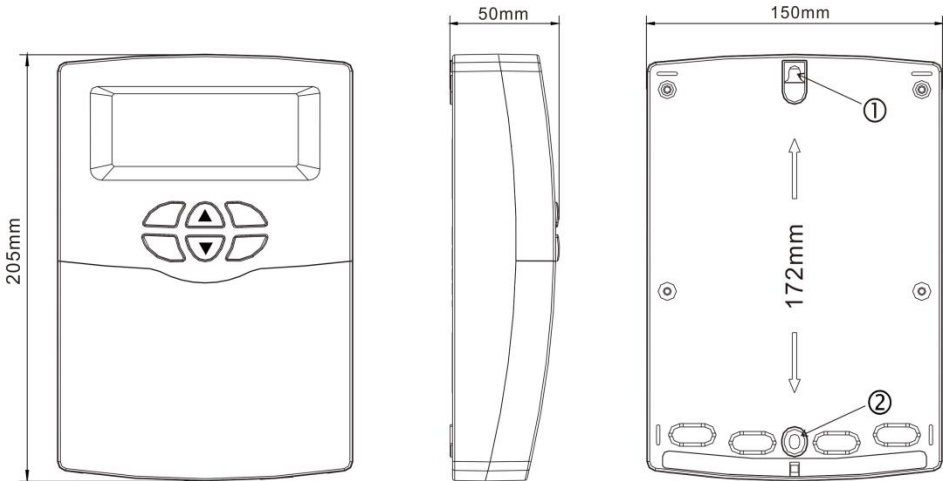

Note: the controller can only be installed in the place having an adequate level of protection.

- ▶ Choosing a suitable site
- ▶ Drilling the upper fixing hole ①
- ▶ Screwing on the screw
- ▶ Taking away the cover plate
- ▶ Hanging the bottom plate on the fixing hole ①
- ▶ Marking the position of bottom fixing hole ②
- ▶ Taking away the bottom plate
- ▶ Drilling the hole ②
- ▶ Re-hanging the bottom plate on screw ①
- ▶ Fixing bottom plate with screw ②

2.2 Power connection

Depending on the type of installation, the cables may enter the device through the rear hole of the case ③ or the base side hole of the case ④



Notes: the flexible wire must be fastened to the case using the strain-relief

clamps provided.

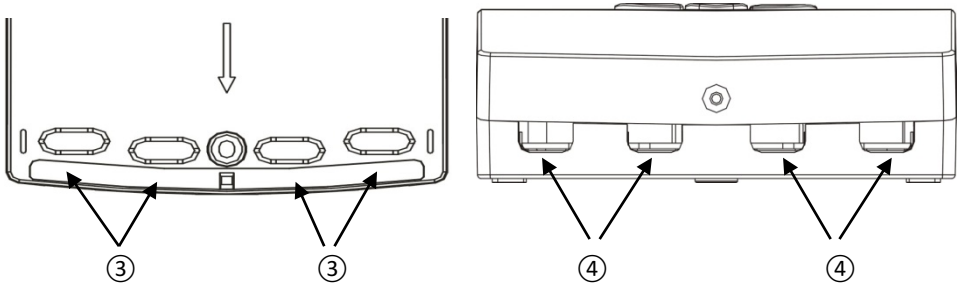



2.3 Terminal port connection

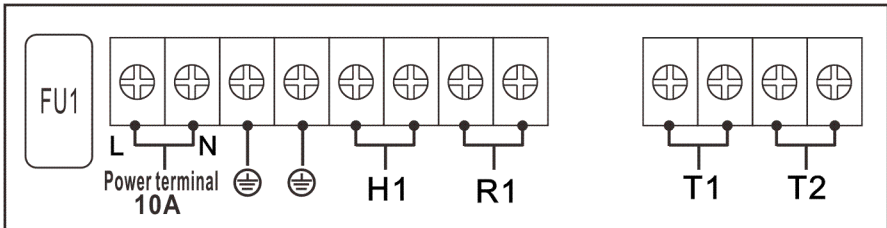

Before opening the terminal, please be sure to switch-off the power and pay attention to the local electricity supply rules.

- **Terminal layout of controller for electrical heater of 1500W**



- **FU1:** the fuse of controller, AC250V/2A
- **Power terminal N, L:** 10A, for power connection, L: live wire, N: zero wire,  protective ground wire, please connect the ground reliably.
- **Output ports**
 - H1:** designed for electrical heater, electromagnetic relay, max. power is 1500W,
 - R1:** designed for anti-freezing heating cables, electromagnetic relay, max. power is 500W
- **Input ports**
 - Input port T1:** for NTC10K, B=3950, $\leq 135^{\circ}\text{C}$ sensor (PVC cable $\leq 105^{\circ}\text{C}$)

designed for measuring the temperature of tank.

Input port T2: for NTC10K, B=3950, $\leq 135^{\circ}\text{C}$ sensor (PVC cable $\leq 105^{\circ}\text{C}$), optional temperature sensor

- **Terminal layout of controller for electrical heater of 3000W**

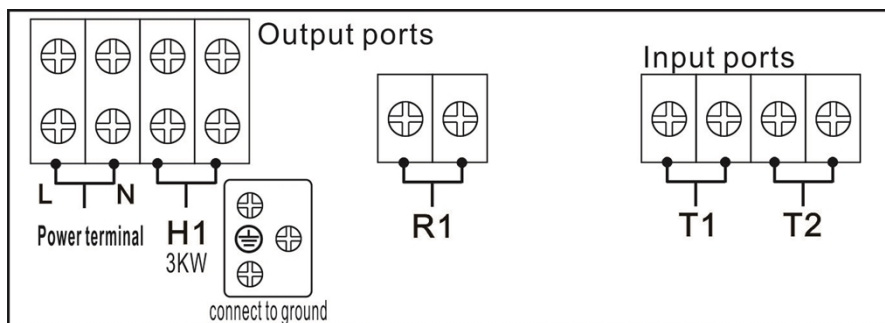

➤ **Power terminal N, L:** AC220V, 20A, for power connection, L: live wire, N: zero wire, \oplus protective wire, please connect to ground reliably.

➤ **Output ports**

H1: designed for electrical heater, electromagnetic relay, max. power is 3000W,

R1: designed for anti-freezing heating cables, electromagnetic relay, max. power is 500W

➤ **Input ports**

Input port T1: for NTC10K, B=3950, $\leq 135^{\circ}\text{C}$ sensor (PVC cable $\leq 105^{\circ}\text{C}$) designed for measuring the temperature of tank.

Input port T2: for NTC10K, B=3950, $\leq 135^{\circ}\text{C}$ sensor (PVC cable $\leq 105^{\circ}\text{C}$), optional temperature sensor(Optional).

i **Note:** sensor T2 is not included in the standard delivery package, self-purchase if need.

- **Advice regarding the installation of temperature sensors:**

▶ Only original factory equipped NTC10K, B=3950 temperature sensors are

approved for using with tank, it is equipped with 20m PVC cable, and the cable is temperature resistant up to 105°C, connect the temperature sensors to the corresponding terminals with either polarity.

- ▶ All sensor cables carry low voltage, and to avoid inductive effects, must not be laid close to 230 Volt or 400 Volt cables (minimum separation of 100mm).
- ▶ Sensor cables may be extended to a maximum length of ca. 100 meter, when cable's length is up to 50m, and then 0.75mm² cable should be used. When cable's length is up to 100m, and then 1.5mm² cables should be used.

3. System diagram

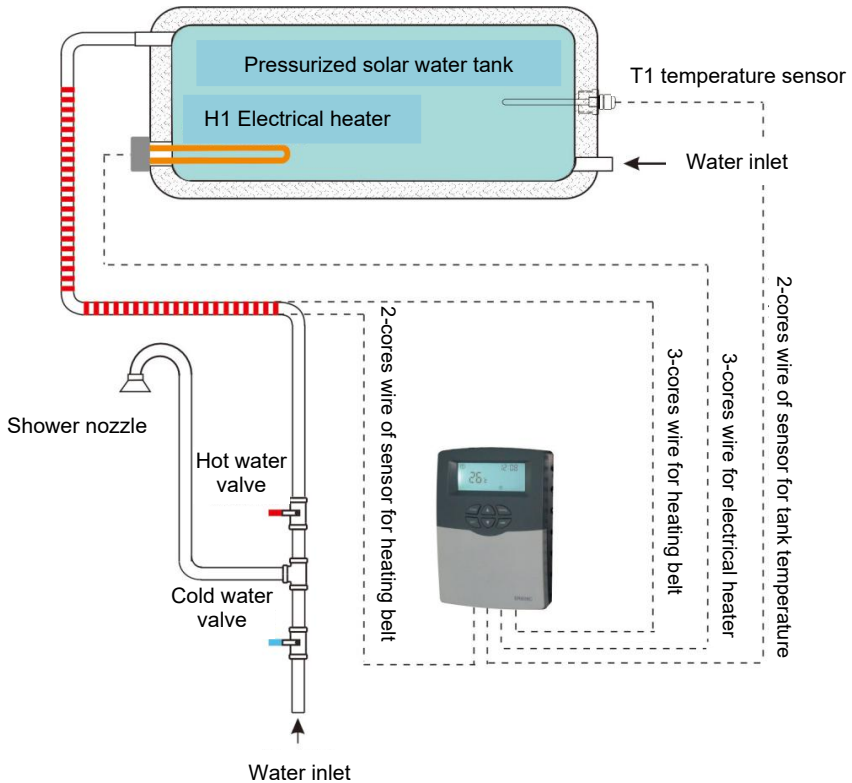

Note: this diagram is only for reference.

4. Functions operation





Before switching-on the power, please connect sensor to the input port of controller, connect electrical heater to the output port of controller.

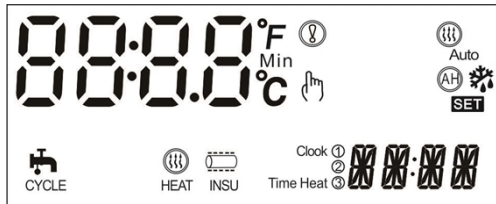

After power is switch on, the controller runs an initialization phase for 5 seconds, then controller runs a commissioning menu, it leads the user through the most important adjustment channels needed for operating the system.

4.1 Signals on display and function code



LCD display screen

Code	Description	Code/Signal Lighting	Code/Signal Blink
 Auto mode	Intelligent heating	Function is activated	Function is running
OTDI	Thermal disinfection function (check under menu)		Countdown of disinfection function working (DDIS)
OTF	Timer (check under menu)		
 INSU	Time controlled pipe heating belt	Function is activated	Function is running
 HEAT	Timing heating function	Function is activated	Function is running
	Temperature controlled DHW within 3 time - sections	Function is activated	Function is running
	Time controlled DHW within 3 time - sections	Function is activated	Function is running

AH	Automatic thermostat	Function is activated	Function is running
ECO	ECO mode (check under menu		
	Anti-freezing protection	Function is activated	Function is running
	Manual heating function		
	Warning of sensor error		

4.2 Button Description

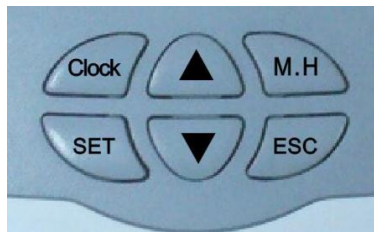

Layout of button

- Button description

“CLOCK” button: current time setting

“M.H” button: manual heating switch on/off

“SET” button: confirm the setting or activate the set value

“ESC” button: exit or return to the previous menu

“▲” button: increase adjustable value or upwards menu

“▼” button: decrease adjustable value or downwards menu

Press “▲” for 3 seconds: switch on/off the intelligent heating function

Press “▼” for 3 seconds: switch on/off the eco operation mode

▶ Press “SET” button for 3 seconds to access addition main menu

- Main menu operation steps

- ▶ 1. Press “SET” button to access the timing heating function menu
- ▶ 2. Press “SET” button for 3 seconds to access main menu
- ▶ Press “▲▼” to adjust the menu
- ▶ Press “SET” to access submenu

- Submenu operation steps

- ▶ Press “SET” to access submenu
- ▶ Press “SET” again to the adjustable item, press “▲▼” to select “ON” to activate the option, or select “OFF” to deactivate this option
- ▶ Press “SET” or “ESC” to confirm the adjust
- ▶ Press “▲” to access the next submenu
- ▶ Press “SET” to the adjustable value
- ▶ Press “▼▲” to adjust value
- ▶ Press “SET” or “ESC” to confirm the adjust

 **Note:** after accessing the adjust channel, if no any button is pressed for 3 minutes, then display returns to the main interface.

4.3 Menu structure

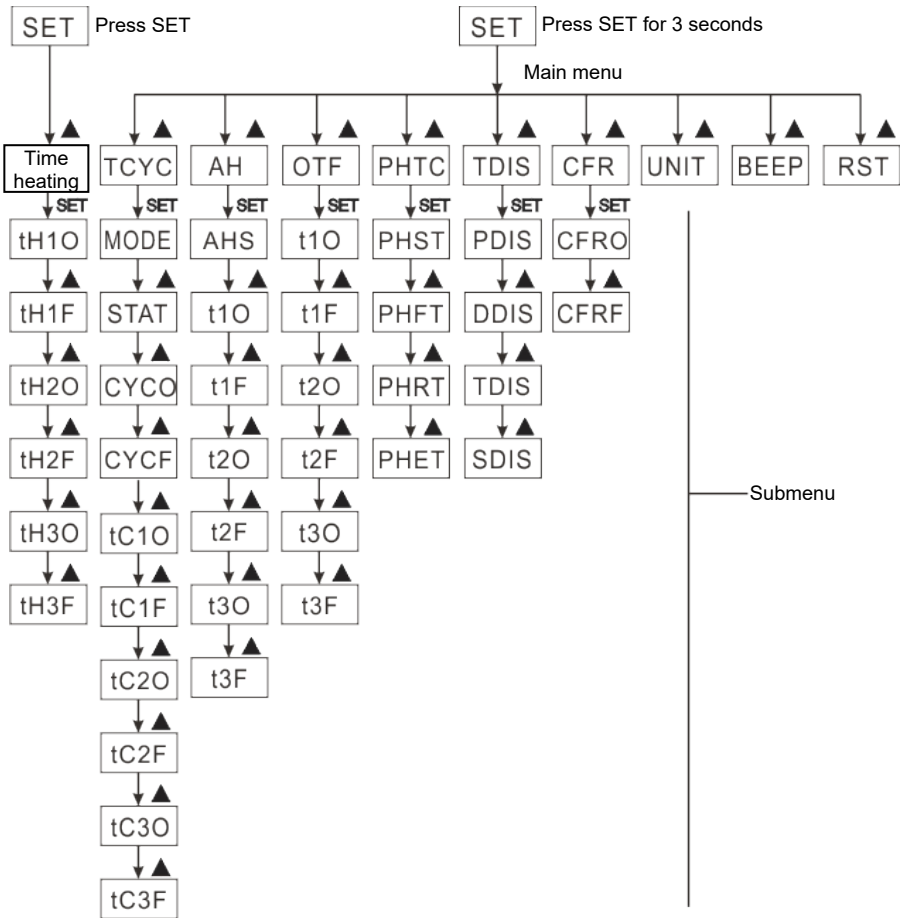

- It is possible to given a detailed set through the submenu, please completely learn the submenu.

4.4 Menu description

Code (Main menu)	Code (Submenu)	Default value	Description
THET			Timing heating
TCYC		OFF	Set the temperature and time of DHW circulation pump within time sections
	MODE	FS	With three time sections flow switcher control model.
		tEP	With three time sections temperature control model.
	STAT	ON	Switch-on condition of temperature control of DHW circulation pump
	CYCO	40°C /03MIN	Switch-on temperature and time of DHW circulation pump
	CYCF	45°C /15MIN	Switch-off temperature and time of DHW
AH		OFF	Automatic thermostat
	AHS	S2	Selection of sensor for thermostat function
OTF		OFF	Timer
PHTC		OFF	Pipe heating protection
	PHST	00:00	Start time of pipe heating
	PHFT	23:59	Stop time of pipe heating
	PHRT	10MIN	Set the running time of pipe heating
	PHET	30MIN	Set the interval time of pipe heating
TDIS		OFF	Thermal disinfection
	PDIS	07	Monitoring days
	DDIS	10MIN	Disinfection running time
	TDIS	70°C	Disinfection running temperature
	SDIS	18:00	Start time of disinfection
CFR		OFF	Tank anti-freezing protection
	CFRO	03°C	Switch-on temperature of anti-freezing protection
	CFRF	05°C	Switch-off temperature of anti-freezing protection
UNIT		°C	Temperature unit selection
BEEP		OFF	Warning of sensor error
RST			Reset to factory value

i **Note:** R1 output port is designed for one of functions from TCYC, AH, OTF, PHTC, if one of these functions is selected and is activated, and then the others can't be activated in the menu, and displays NONE.

5. Main functions

5.1 Setting time

▶ Press “Clock” button, time displays on the screen, hour “00” blinks on the screen.

▶ Press “▲▼” button to set hour of clock

▶ Repress “Clock”, minute “00” blinks

▶ Press “▲▼” button to set minute of clock.

▶ Press “Clock” to exit program, or waiting for 20 seconds, controller exits automatically, the set parameters are saved automatically.



Note: at the case that power is switched-off, time can be kept for 36 hours.

5.2 THEH Timing heating

Description:

Electrical heater can be integrated into solar system used as back-up heating of system, and it can be triggered automatically at preset time by preset temperature. Within a preset time-section, when the temperature (T1) of tank drops below the preset switch-on temperature of this function, electrical heater (H1) starts to work, when T1 rises to the preset switch-off temperature, electrical heater (H1) is stopped.

Within 24 hours, three time-sections can be set with this controller.

Factory set:

The first time-section: electrical heating function starts at 4:00 and ends at 5:00 am. Within this time-section, switch-on temperature is 40°C, switch-off temperature is 50°C.

The second time-section: from 10:00 to 10:00 am, it means there is no electrical heating in this time.

The third time-section: electrical heating function starts at 17:00 and ends at 22:00 pm. Within this time section, the switch-on temperature is 50°C, switch-off temperature is 55°C.

If you want to shut off one timing heating, then you can set the turning on time and turning off time same value (for example, the second time-section no this function, then you can set turning on/off time is 10:00 ~ 10:00)

The switch-on temperature adjustable range: 0°C ~ (OFF-2 °C)

The switch-off temperature adjustable range: (ON+2 °C) ~ 95°C

When time is outside of the preset time-section, electrical heating doesn't work automatically even when the tank temperature reaches the switch –on temperature of heating.

Setup steps:

▶ Press “SET” button to access the main menu and select menu “THET”.



▶ Press “SET” button again, to access the setting interface, the first switch-on time and temperature parameters “th10 04:00” displays and blinks on the screen.

▶ Press “SET” button, hour “04” blinks on the screen.

▶ Press “▲▼” button, to set hour of the switch-on time of heating

▶ Press “SET” button, minute “00” blinks on the screen.

▶ Press “▲▼” button, to set minute of the switch-on time of heating

▶ Press “SET” button, temperature “40” blinks on the screen.

▶ Press “▲▼” button, to set the switch-on temperature of heating.

▶ Press “SET” or “ESC” button to confirm.

▶ Press “▲” button, to access the first switch-off time and temperature parameters, “th1F 05: 00 ”displays and blinks on the screen.



▶ Press “SET” button, hour “05” blinks on the screen.

▶ Press “▲▼” button, to set hour of the switch-off time of heating

▶ Press “SET” button, minute “00” blinks on the screen.

▶ Press “▲▼” button, to set minute of the switch-off time of heating

▶ Press “SET” button, temperature “45” blinks on the screen.

▶ Press “▲▼” button, to set the switch-on temperature of heating.

▶ Press “SET” or “ESC” button to confirm.

▶ Press “▲” button, to access the second switch-on time and temperature parameters, “th2O 04: 00 ”displays and blinks on the screen. Doing like above steps to set time and temperature for the second time-section and the third time-section.

When heating signal  displays on the screen, it indicates timing heating is activated.

5.3 M.H Manual heating

Description:

You can manually trigger the back-up electrical heater to adjust the tank temperature. When controller measures the temperature T1 is below the desired temperature, it will trigger the electrical heater, and it is working until the tank temperature (T1) rises to the desired temperature.

Activate/deactivate the function

▶ Press “M.H” button f, temperature “60 °C” blinks on the screen.



▶ Press “▲▼” button to adjust the desired

temperature, adjustable range 10°C~80 °C, factory set is 60 °C

- ▶ Press “M.H” or press “ESC” button or waiting for 20 seconds to start the manual heating function, and displays manual heating signal .
- ▶ Press “M.H” again, to switch-off manual heating function.

i **Note:** manual heating can heat tank only for one time, when manual heating function is activated, tank is heated until its temperature reaches to the desired value, and then manual heating is deactivated automatically.

5.4 Intelligent heating mode

At the case that solar energy is not enough, in order to ensure the enough hot water for customer, controller will automatically measure the tank temperature at the set time, if the default temperature is not reached, controller trigger the electrical heater to heat tank until the temperature rises to the default value.

Factory set (unchangeable):

The first heating time is 13:00 and desired temperature is 30°C

The second heating time is 14:00 and desired temperature is 35°C,

The third heating time is 15:00, desired temperature is 40°C,

The forth heating time is 16:00, desired temperature is 45°C,

The fifth heating time is 17:00, desired temperature is 50°C,

Setup steps:

▶ Press “▲” button for 3 seconds, the intelligent heating signal displays on the screen, intelligent heating mode is activate.



▶ Press “▲” button for 3 seconds again, the intelligent heating signal is closed, intelligent heating mode deactivated.

When intelligent heating signal blinks on the screen, it indicates this function is working.

5.5 Economic mode

Description:

At the case of economic mode, timing heating function is deactivated automatically; heating can only be triggered by manual heating function (M.H).

Activate/deactivate this function:

- ▶ Press “▼” button for 3 seconds, eco mode activated.
- ▶ Press “▼” button for 3 seconds again, eco mode deactivated.

Under standby status, press “▲” to check, “ECO ON” Indicates the eco mode is switched-on.



Note: if the timing heating function is needed to be used, then the eco mode should be deactivated.

6. Additional functions



Note: press “SET” for 3 seconds to access the additional functions menu.

6.1 TCYC Setting the temperature / flow for DHW pump running within three time-sections

Description:

Purpose of this function is ensuring user can get hot water quickly. 2 control modes are designed in this controller: timing temperature controlled mode and timing flow rate controlled mode. For this function, a DHW circulation pump R1 and flow switcher or a temperature sensor T2 mounted on the DHW return pipe should be installed in the system.

DHW pump running at below 2 modes:

- controlled by flow switcher within the three time-sections
- controlled by temperature within the three time-sections

i Note:

1. Only one of two control modes can be selected to control DHW pump.
2. The setting steps for time controlled mode and temperature controlled mode is same.

● **DHW pump controlled by temperature within the three time-sections (tEP)**

When sensor T2 is connected to the controller, then temperature controlled mode is selected automatically, within a running time section, as default set, DHW pump R1 runs when T2 is below 40°C, and DHW pump R1 stops when T2 reaches to 45°C

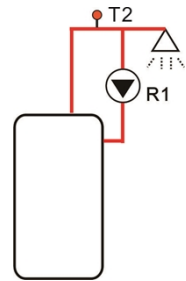

Startup condition for temperature controlled mode (STAT): when tank temperature T1 is 2°C higher than the preset switch-off temperature(CYCF), and then DHW circuit pump is triggered.

Default time sections:

The first time-section starts at 05.00 a.m., closes at 7:00a.m.

The second time-section starts at 11.00 a.m., closes at 13:00 p.m.

The third time-section starts at 17.00 p.m., closes at 22:00p.m.

i Note: If sensor T2 should be installed, to avoid measuring error, please ensure a safety distance of 1.5m to tank.

● **DHW pump controlled by flow switcher within the three time-sections (FS)**

Description:

Install a flow switcher on the cold-water pipe, and then open the tap, when there is flow through the hot water pipe, flow switcher gets signal and sends it to controller, and then DHW pump is triggered to transport the hot water from tank to tap. The running time of DHW pump is adjustable, running time finished, DHW pump is stopped.

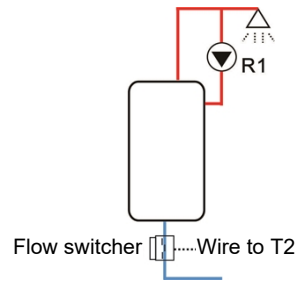

Tap seems like a remote controller, it controls the running of DHW pump. This control mode of DHW pump is an energy saving solution.

Open the tap for a short time, then flow switcher installed on the cold-water pipe will get the flow signal and sends it to the controller, and then controller triggers DHW pump R1 to transport the hot water from tank into circulation pipe. Then when you open the tap again, hot water can flow out immediately, the running time finishes, DHW pump will stop automatically. When no more hot water is needed, in order to avoid hot water is cooled by circulation, DHW pump will be stopped when its running time finished. And to avoid the DHW pump is triggered again just after its stop, a parameter of interval time is designed for this purpose.

as default set, DHW pump runs for 3 minutes and then ceases for 15 minutes, same process repeated within the running time section. Running time can be adjusted from 1-30Min; interval time can be adjusted from 0-60Min.

i Note:

1. To avoid the mixing of water in the tank with water in the circulation pipe, a one-way valve should be installed before pump.
2. If the interval time (CYCF) is set to 0 minute, then within the time-section, DHW pump keeps running without any intervals. Close the tap, pump is

ceased automatically.

Default time sections:

The first time-section starts at 05.00 am, closes at 7:00am.

The second time-section starts at 11.00 am, and closes at 13:00pm.

The third time-section starts at 17.00 pm, and closes at 22:00pm.

- Flow switcher fitting:

Material: Brass

House: plastics

Connection: G3/4

Reed: Max 300VDC/1A



i **Note:**

- 1) Note the water flow direction of flow switcher.
- 2) Flow switcher is connected to port T2 with either polarity.
- 3) Flow switcher is not included in the standard delivery list, if need please purchase it separately.
- 4) Only one of two control modes can be selected to control DHW pump, it is impossible to use them at the same time.
- 5) If sensor T2 should be installed, to avoid measuring error, please ensure a safety distance of 1.5m to tank.
- 6) The setting steps for flow switcher controlled mode and temperature controlled mode is same.

Setup steps (example with temperature controlled mode)

▶ Press “SET” button for 3 seconds, to access the main menu and select menu “TCYC”.

▶ Press “SET” button again, “TCYC OFF” displays on



the screen.

- ▶ Press “SET” button, “OFF” blinks on the screen.
- ▶ Press “▲▼” button, to activate this function
- ▶ Press “SET” or “ESC” button to confirm.

▶ Press “▲” button, “MODE FS” displays on the screen, to select the DHW pump control mode

- ▶ Press “SET” button again, “FS” blinks on the screen.
- ▶ Press “▲▼” button, to select control mode
- ▶ Press “SET” or “ESC” button to confirm.

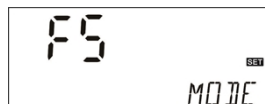

▶ Press “▲” button, “STAT ON” displays (startup temperature of DHW pump, this menu is only displayed under temperature control mode)

- ▶ Press “SET” button again, “ON” blinks on the screen (default is on) .

- ▶ Press “▲▼” button, to deactivate this function
- ▶ Press “SET” or “ESC” button to confirm.

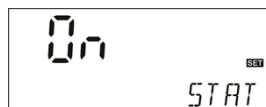

▶ Press “▲” button, “CYCO 40°C” displays (switch –on temperature of DHW pump, if control mode flow switcher is selected, then here “CYCO 03MIN” displays)

- ▶ Press “SET” button again, “40 °C” blinks on the screen.

▶ Press “▲▼” button, to adjust switch-on temperature, adjustable range 0 °C~ (OFF-2 °C)

- ▶ Press “SET” or “ESC” button to confirm.



▶ Press “▲” button, “CYCF 45°C” displays (switch –off temperature of DHW pump)

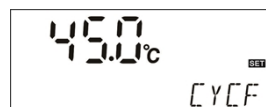

-
- ▶ Press “SET” button again, “45 °C” blinks on the screen.
 - ▶ Press “▲▼” button, to adjust switch-off temperature, adjustable range (ON+2 °C) ~55 °C.
 - ▶ Press “SET” or “ESC” button to confirm.

▶ Press “▲” button, to the first time-section setting, “tC 1O 05:00” displays (switch –on time of the first time-section of DHW pump)

▶ Press “SET” button again, hour “05” blinks on the screen.



- ▶ Press “▲▼” button, to adjust hour of the switch-on time
- ▶ Press “SET” button again, minute “00” blinks on the screen.
- ▶ Press “▲▼” button, to adjust minute of the switch-on time
- ▶ Press “SET” or “ESC” button to confirm.

▶ Press “▲” button, to the first time-section setting, “tC 1F 07:00” displays (switch–off time of the first time-section of DHW pump)

Press “SET” button again, hour “07” blinks on the screen.

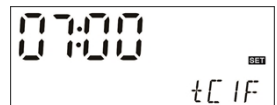

- ▶ Press “▲▼” button, to adjust hour of the switch-off time
- ▶ Press “SET” button again, minute “00” blinks on the screen.
- ▶ Press “▲▼” button, to adjust minute of the switch-off time
- ▶ Press “SET” or “ESC” button to confirm.

▶ Press “▲” button, to the second time-section setting, “tC 2O 11:00” displays (switch-on time of the second time-section of DHW pump), repeat above steps to set the second time-section and the third time-section.

 Note: If it is needed to close one time-section, just set its start time and stop time at a same value (e.g. 10:00 starts, 10:00 stops)

When DHW pump signal  displays and blinks, it indicates that temperature controlled DHW pump mode is running.

When signal  displays and blinks, it indicates the flow switcher controlled DHW pump mode is running.

6.2 AHO Automatically thermostat function

Automatically thermostat function is independent from solar system, it is used to release the extra heat to reduce the tank temperature or to trigger back-up heater to heat tank to the desired temperature. This function needs an electromagnetic valve or circulation pump R1, corresponding temperature sensor is T2 or T1.

Note:

AHO<AHF: this thermostat function is used to control the back-up heater

AHO>AHF: this thermostat function is used to release the extra heat from tank

- ▶ Select main menu AH
- ▶ Press “SET” button, parameter “OFF” blinks on the screen
- ▶ Press “▲▼” to activate this function
- ▶ Press “SET” or “ESC” button to confirm the set.



- ▶ Press “▲” button, parameter “AHS S2” appears (sensor selected for this function, S1 presents T1, S2 presents T2)

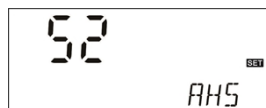

- ▶ Press “SET” button, parameter “S2” blinks on the screen
- ▶ Press “▲▼” to select sensor
- ▶ Press “SET” or “ESC” button to confirm.

- ▶ Press “▲” button to access the setting program of timer of the thermostat function, “t1 0 00: 00” displays, it is ready for set the start time of the first

time-section.

▶ Press “SET” button, hour “00” blinks on the screen

▶ Press “ ▲ ▼ ” to set hour of the start time



▶ Press “SET” button, minute “00” blinks on the screen

▶ Press “ ▲ ▼ ” to set minute of the start time

▶ Press “SET” button, temperature “40°C” blinks on the screen, adjustable range is 0°C ~ 95°C

▶ Press “ ▲ ▼ ” to set the switch-on temperature of the thermostat function.

▶ Press “SET” or “ESC” button to confirm.

▶ Press “ ▲ ” button to access the setting program , “t1F 23: 59 ”displays, it is ready for set the close time of the first time-section.

▶ Press “SET” button, hour “23” blinks on the screen

▶ Press “ ▲ ▼ ” to set hour of the close time

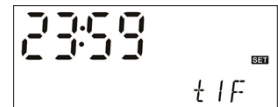

▶ Press “SET” button, minute “59” blinks on the screen

▶ Press “ ▲ ▼ ” to set minute of the close time

▶ Press “SET” button, temperature “45°C” blinks on the screen, adjustable range is 0°C ~ 95°C

▶ Press “ ▲ ▼ ” to set the switch-off temperature of the thermostat function.

▶ Press “SET” or “ESC” button to confirm.

▶ Press “ ▲ ” button to access the setting program of second time-section, repeat above steps to set second time section and the third time-section.

When the signal of thermostat “AH” is blinks on the screen, it indicates that the thermostat function is running.

6.3 OTF Three time-sections set (Timer function)

Description:

Controller has timer function, within the set time section, output R1 is

switched-on; outside the time section, and then output R1 is switched-off.

Setup steps:

- ▶ Select OTF DHW circulation main menu.
- ▶ Press “SET” button, “OFF” displays on the screen.
- ▶ Press “▲▼” button to activate the function
- ▶ Press “SET” or “ESC” to confirm



- ▶ Press “▲” button to access the setting program to set the timer, “t1O 00:00” displays on the screen, it is ready for setting the start time of the first time-section.

- ▶ Press “SET” button, hour “00” blinks
- ▶ Press ‘▲▼’ button to adjust hour of the start time
- ▶ Press “SET” button, minute “00” blinks,
- ▶ Press ‘▲▼’ button to adjust minute of the start time
- ▶ Press “SET” or “ESC” to confirm



- ▶ Press“ ▲”button to set the close time of the first time section, “t1F 00: 00”displays on the screen.

- ▶ Press “SET” button, hour “00” blinks
- ▶ Press “▲▼” button to adjust hour of the close time
- ▶ Press “SET” button, minute “00” blinks,
- ▶ Press “▲▼” button to adjust minute of the close time
- ▶ Press “SET” or “ESC” to confirm



- ▶ Press “▲” button to access the program of setting the second time section, repeat above steps to set the second time section and third time section.

 Note:

1. If it is needed to close one time-section, just set its start time and stop time

at a same value (e.g. 10:00 starts, 10:00 closes)

2. under standby status, press “▲/▼” to check, “OTF ON” indicates the timer function is activated. “ON” blinks, it indicates the timer function is running.

6.4 PHTC Time controlled pipe belt heating protection

Description:

In winter, when outdoor temperature is lower, controller will trigger the pipe belt heating protection function to avoid pipe leakage due to freezing.

Example: at the pre-set time section, if running time of pipe belt heating is set with 10 minutes, the interval time of pipe belt heating is set with 30 minutes, then the heating function runs for 10 minutes, then it stops for 30 minutes, this heating process is repeated within the time section, through this setting, it can avoid giving power to heating wires for long time, saving electricity and can avoid fire due to aging of wire.

Setup steps:

- ▶ Select menu PHTC pipe heating function.
- ▶ Press “SET” button, “OFF” blinks on the screen
- ▶ Press “▲ ▼” button to activate this function
- ▶ Press “SET” or “ESC” to confirm



- ▶ Press “▲ ” to access the setting program, “PHST 00:00” Displays on the screen, it is ready to set the start time of the first time-section.

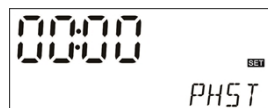

- ▶ Press “SET” button, hour “00” blinks
- ▶ Press “ ▲ ▼ ” button, adjust the hour of the start time of belt heating
- ▶ Press “SET” button, minute “00” blinks
- ▶ Press “▲ ▼” button to adjust the minute of the start time
- ▶ Press “SET” or “ESC” to confirm

▶ Press “▲” button, “PHFT 23:59” displays on the screen, it is ready to set the close time of the first time section.

▶ Press “SET” button, hour “23” blinks

▶ Press “▲▼” button, adjust the hour of the close time



▶ Press “SET” button, minute “59” blinks

▶ Press “▲▼” button to adjust the minute of the close time

▶ Press “SET” or “ESC” to confirm

▶ Press “▲” button to set the running time of pipe heating function, “PHRT 10MIN” displays on the screen.

▶ Press “SET” button, “10MIN” blinks

▶ Press “▲▼” button, to adjust the running time of pipe heating, (minute) adjustable range is 1~60MIN.

▶ Press “SET” or “ESC” to confirm



▶ Press “▲” button to set the interval time, “PHET 30MIN” displays on the screen

▶ Press “SET” button, “30MIN” blinks

▶ Press “▲▼” button to adjust the interval (minute), adjustable range is 0~90MIN.

▶ Press “SET” or “ESC” to confirm



When the pipe anti-freezing signal  blinks on the screen, it indicates that the pipe anti-freezing function is activated.



Note: if the interval time PHET is set with 0 minute, then within the time section, pipe belt heating will run without stop.

6.5 TDIS Thermal disinfection

Description:

To avoid occurring bacteria in water tank, controller will trigger the back-up heater to heating tank to the required temperature to kill the bacteria. Therefore, tank temperature T1 is monitoring by controller at the monitoring period (PDIS), if the temperature is not reached to the desired disinfection temperature (TDIS) during this monitoring period PDIS, then controller will trigger the electrical heater at the preset start time (SDIS), and controller will heat tank and ensure the temperature during the heating period (DDIS) is always higher than the desired disinfection temperature (TDIS). When thermal disinfection function is working (DDIS time starts), DDIS countdown time starts, countdown time finished, thermal disinfection heating is stopped. This function stops.

Setup steps:

- ▶ Select TDIS thermal disinfection main menu
- ▶ Press “SET” button, “OFF” blinks
- ▶ Press“ ▲ ▼ ” button, to activate this function
- ▶ Press “SET” or “ESC” to confirm



- ▶ Press“ ▲ ”button, to set the days of a thermal disinfection period, “PDIS 07”displays on the screen.

- ▶ Press “SET” button, “07” blinks
- ▶ Press“ ▲ ▼ ” button, to set the days of a thermal disinfection period, adjustable range is 1-30 days.
- ▶ Press “SET” or “ESC” to confirm

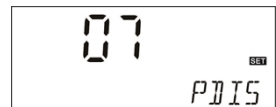

- ▶ Press“ ▲ ”button, to set the disinfection heating time “DDIS 10” displays.
- ▶ Press “SET” button, “10” blinks on the screen.
- ▶ Press “▲ ▼ ”button, to set the heating time, adjustable time is 1-120 minutes



▶ Press “SET” or “ESC” to confirm

▶ Press“ ▲ ”button to set the heating temperature,

“TDIS 70”displays on the screen.



▶ Press “SET” button, “70°C” blinks

▶ Press “ ▲▼ ”button, set the heating temperature, the adjustable range is 0-90°C

▶ Press “SET” or “ESC” to confirm

▶ Press“ ▲ ”button to set the start time of thermal disinfection function, “SDIS

18: 00”displays on the screen.



▶ Press “SET” button, “18” blinks

▶ Press “▲▼ ”button to set the start time of thermal disinfection function

▶ Press “SET” or “ESC” to confirm

Under standby status, press “▲” button to check. “OTDI 10min” indicates disinfection function is activated. Disinfection temperature TDIS is reached, then countdown of DDIS starts.

6.6 CFR Tank anti-freezing protection

Description:

In winter, when outdoor temperature is very low, to avoid freezing of collector tube/ tank, when controller measures the tank temperature T1 drops to only 3°C (factory set), controller will trigger the electrical heater to heat tank until its temperature rises to 5°C, and then tank anti-freezing function is deactivated automatically.

Setup steps:

▶ Select main menu CFR tank anti-freezing protection function

- ▶ Press “SET” button, “OFF” blinks
- ▶ Press “▲▼” button to activate the function
- ▶ Press “SET” or “ESC” to confirm



- ▶ Press“ ▲”button, “CFRO 03”displays (switch-on temperature of tank anti-freezing protection)



- ▶ Press “SET” button, “03” blinks
- ▶ Press“ ▲▼ ”button to adjust the switch on temperature for this function, adjustable range is 0-8°C)
- ▶ Press “SET” or “ESC” to confirm

- ▶ Press“ ▲”button, “CFRF 05”displays (Switch-off temperature of tank anti-freezing protection)



- ▶ Press “SET” button, “05” blinks
- ▶ Press“ ▲▼ ”button, to adjust the switch-off temperature, adjustable range is 2-10 °C.
- ▶ Press “SET” or “ESC” to confirm

When anti-freezing signal ❄️ blinks, it indicates anti-freezing function is activated.

6.7 UNIT Celsius degree and Fahrenheit unit switch

Setup steps:

- ▶ Select this function menu UNIT,
- ▶ Press “SET” button, “TEMP °C” displays on the screen
- ▶ Press “SET” button again, “°C” blinks
- ▶ Press ‘▲▼’ to switch the temperature unit
- ▶ Press “SET” or “ESC” to confirm

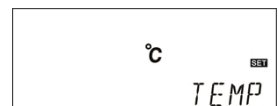

6.8 BEEP Beeper error warning

When temperature sensor has error, this function will send warning to manager.
When beeper sounds, press “ESC” to exit the warning function.

Setup step:

- ▶ Select BEEP warning function menu
- ▶ Press “SET” button, “BEEP OFF” displays
- ▶ Press “SET” button, “OFF” blinks
- ▶ Press “ ▲ ▼ ” button to activate the function
- ▶ Press “SET” or “ESC” to confirm



6.9 RST Reset function

Through this function, it is possible to recover all parameters to the factory set.

Setup steps:

- ▶ Select RST main menu
- ▶ Press “SET” button, “YES” blinks
- ▶ Press “SET” button for 3 seconds, then beeper sounds “di....” 3 times, and then “YES” lighting, it indicates the controller program is recovered to the factory set.
- ▶ Press “SET” or “ESC” to confirm

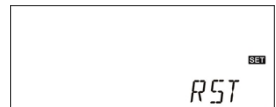

7. View the measuring value

When controller works normally, by pressing “ ▲ ▼ ” button, it is possible to view the T1, T2 temperature value, running time and software version.

 Note:

1. T2 value can be viewed only when the corresponding function is activated.
2. When timer (OTF), disinfection function(TDIS), Eco mode (ECO) function is activated, it is also possible to view under menu.
3. At the view status, if no any button is pressed within 3 minutes, display returns to the main interface.

8. Protection function

8.1. Memory protection

In case power failure occurs, controller keeps the parameter settings unchanged.

8.2 Screen protection

When no any press on button for 5 minutes, screen protection is activated automatically, and then LCD lighting lamp is switched-off. Through press any button to light LCD lamp again.

8.3 Trouble protection

When temperature sensor's (T1) wiring is interrupted, not connected or short circuit, controller switches off the corresponding signal output, and simultaneously “- - -” error code displays on the screen.

9. Quality Guarantee

The warrantee expires within 12 months after the date of purchasing the controller.

10. Technical specification

- Power supply: AC100-240V,50-60Hz
- Power consumption: < 3W
- Accuracy of temperature measuring: $\pm 2^{\circ}\text{C}$
- Range of tank temperature measuring: 0 ~100 °C
- Inputs: T1: NTC10K, B3950 sensor ($\leq 135^{\circ}\text{C}$) for tank, (PVC cable $\leq 105^{\circ}\text{C}$),
T2: temperature sensor, optional
- Outputs: H1 for electrical heater, R1: Relay.
- Ambient temperature : $-10^{\circ}\text{C} \sim 50^{\circ}\text{C}$.
- Water proof grade: IP40.

11. Delivery list

- Controller 1 piece
- Power cable 10A (for controller of 3000W, not provided) 1 piece
- Customer manual 1 piece
- NTC10K sensor (size: $\phi 6 \times 50$ mm, cable length 20 m) 1 piece
- Accessories 1 bag